



SELECTABLE WATTAGE & CCT



LDX348 LT. COMMERCIAL • 5YR
LED 4' SPEC-SELECT™
DESIGNER STRIP
DIRECT LINEAR AMBIENT LUMINARIES

FEATURES

Spec-Select™ Designer Strips feature adjustable wattage and color temperature for the perfect balance of light in any application.

- Energy efficient
- No flickering

APPLICATION

Ideal for larger warehouses, retail applications, commercial buildings and work areas.

ELECTRICAL

Wattage	18W / 25W / 30W
Voltage	120-277V
Current	0.25-0.11A
Power Factor	0.9
Total Harmonic Distortion (THD)	10

LIGHTING PERFORMANCE

Lumens	2340-3900
Lumens Per Watt (Lm/W)	130
Color Temperature (CCT)	3500K / 4100K / 5000K
Color Rendering (CRI)	82
R9 (Red Value)	7 / 11 / 8
R13 (Skin Tones)	83 / 83 / 82
Beam Angle	130°
Light Distribution	Very Short, Type II
BUG Rating (Backlight, Uplight, and Glare)	B1 - U3 - G2
Dimmable Lighting Control	<i>Dimmable</i> 0-10V, Range 10% - 100%

ENVIRONMENT

Operating Temperature	-4 ~ 113°F
Suitable Location	DAMP
Ingress Protection Rating	IP40

LIFESPAN

Average Life (Hours)	50,000
Warranty (Years)	5

COMPONENTS

LED Light Source	Seoul 3528
Driver	SIP50-I650

CONSTRUCTION

Housing	Aluminum
Lens	Frosted
Base / Power Supply	Hard Wired
Finish	White

QUALIFICATIONS

Manufacturer Model #	55610
----------------------	-------



Manufactured by P.Q.L., Inc. • Published lumens on LED products are approximate and may vary slightly. • Specifications are subject to change without notice.

LDX348 LT. COMMERCIAL • 5YR LED 4' SPEC-SELECT™ DESIGNER STRIP



ITEM INFORMATION

DIMENSIONS (Inches)

Length	47.3"
Width	3.4"
Height	3.6"
Net Weight (Lbs)	4.5

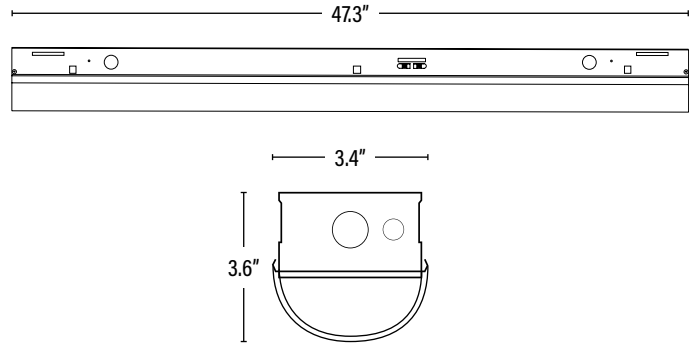

PACKAGING

		UPC	DIMENSIONS (LxWxH)	GROSS WEIGHT (Lbs)
Master Carton	6	10899645001926	49.6" x 11.7" x 8.4"	37.9
Individual Box	1	899645001929	--	6.3
Country of Origin	China			
HS Tariff	9405.10.6020			

ORDERING

ITEM#	DESCRIPTION	CASE
LDX348	LED 4' SPEC-SELECT™ DESIGNER STRIP - 18/25/30W/35-50K/120-277V/DIMMABLE	6

Manufactured by P.Q.L., Inc. - Manufacturer Model # 55610

ACCESSORIES

LF3599	360° LOW/HIGH BAY FIXTURE OCCUPANCY PIR SENSOR 30" DIA, 8-40" HEIGHT 800W/1200W - 120/277V	50
LF3502	EMERGENCY PACK FOR LED FIXTURE 16W/90 MIN/SPLIT TYPE/L T20C (For use with drivers that are 100W or less.)	10

ADDITIONAL INFORMATION:

- Default settings; 30W, 5000K.
- The color temperature and wattage may be adjusted by two slide switches integrated into the driver. The color temperature and wattage should be selected prior to installation.

